

NO	DESCRIPTION	MAT'L	Q'TY	WT(kg)	REMARKS

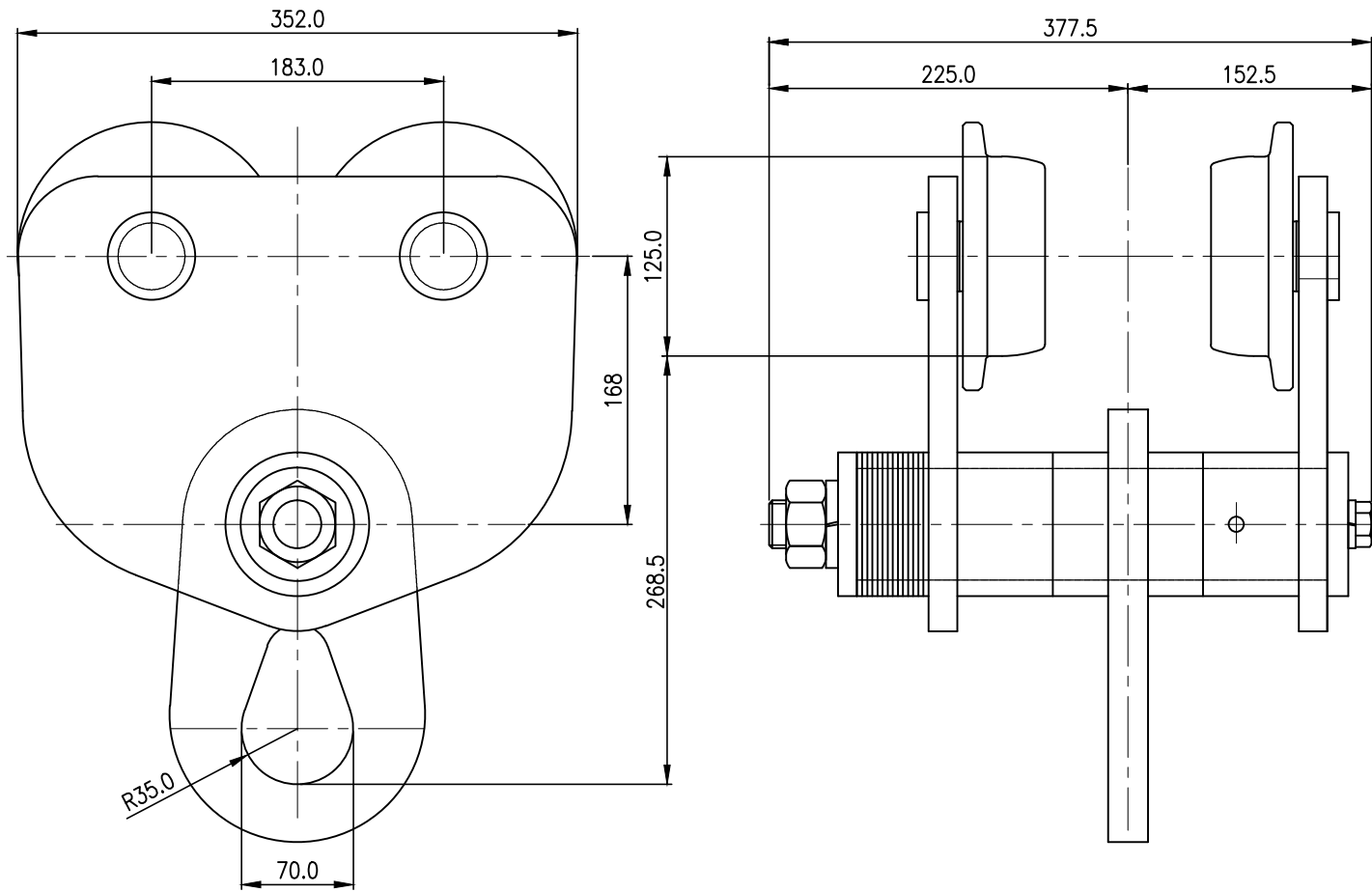

TITLE 10TON PLAIN TROLLEY				PROJECTION	
WORK NO		WORK NAME			
				SCALE	Q'TY
				1/2	1
DRAWN	CHECKED	REVIEWED	APPROVED	DRAWING NO	
YOO.M.R	-	LEE. H.J	Y. K	DSPT100001	
2012.06.25	-	2012.06.21	2012.09.04		
DAESAN INoTEC INC					

REV.NO	DATE	REVISION DESCRIPTION	DRAWN	CHECKED	APPROVED