

  
**DAESAN**<sup>®</sup>  
**HAND CHAIN HOIST**  
**DSN 1/2 - 40 TONS**







## **NOTICE**

It is the responsibility of the owner/user to install, inspect, test, maintain, and operate these hand chain hoists in accordance with Standard for Overhead Hoists.

These general instructions deal with the normal installation, operation and maintenance situations encountered with the hand chain hoists described herein. The instructions should not be interpreted to anticipate every possible contingency or to anticipate the final system or configuration that uses these hand chain hoists. Read and observe the instructions stated in the manual furnished with equipment to be used with these hand chain hoists.

These instructions include information for a variety of hand chain hoists. Therefore, all instructions and information may not apply to one specific hand chain hoist. Disregard those portions of the instructions that do not apply.

If the hand chain hoist owner/user requires additional information, or if any information in these instructions is not clear, contact DAESAN INOTEC INC. Korea or the distributor of the hand chain hoist. Do not install, inspect, test, maintain, or operate this hand chain hoist unless this information is fully understood.

## **⚠ WARNING**

This hand chain hoist should not be installed, operated, or maintained by any person who has not read all the contents of these instructions. Failure to read and comply with these instructions or any of the warnings or limitations noted herein can result in serious bodily injury or death, and/or property damage.

Only trained and qualified personnel shall operate and maintain this equipment.

Equipment described herein is not designed for, and should not be used for lifting, supporting, or transporting humans.

User should not use this hand chain hoist in conjunction with other equipment unless necessary and/or required safety devices applicable to the system are installed by the user.

Modifications to upgrade, rerate or otherwise alter these hand chain hoists shall be authorized only by the original equipment manufacturer or qualified professional engineer.

## **PRIOR TO INSTALLATION**

Check for damage during shipment. Place claim with carrier if any damage is discovered. DO NOT install or use a damaged hand chain hoist.

Check and verify that structure or other equipment that will support the hand chain hoist has a rated load capacity equal to or greater than the rated load capacity of the hand chain hoist to be used.

## **OPERATION**

### **Before initial operation of hoist :**

1. Read and comply with all instructions and warnings furnished with or attached to hoist.
2. Check lubricant.
3. Check operation of brake.
4. Check that chain is properly seated in sheaves and that chain is not twisted, kinked, or damaged.

### **Before each shift:**

1. Inspect hooks for nicks, gouges, cracks, and signs of pulling apart or twist.
2. Inspect hook latch for proper operation.
3. Check chain for kinks or twists.
4. Check operation of brake.
5. Replace warning label if missing or illegible.

### **Before operating :**

1. Be certain all personnel are clear of the load to be lifted and moved.
2. Make sure load will clear stock piles, machinery, or other obstructions when hoisting and traveling the load.
3. Eliminate any twists or kinks in the load chain.



## **SAFETY PRECAUTIONS**

1. READ these instructions and Safety Standard for Overhead Hoists before installing, operating, or maintaining this equipment.
2. DO NOT lift more than rated load.
3. DO NOT operate hoist when it is restricted from forming a straight line with the direction of loading.
4. DO NOT operate with twisted, kinked, or damaged chain.
5. DO NOT operate if chain is not seated in sheaves or sprockets.
6. DO NOT wrap chain around load or use chain as a sling.
7. DO NOT operate unless load is properly applied to the saddle or bowl of the hook.
8. DO NOT operate if load is applied to the tip of the hook.
9. DO NOT operate with damaged or missing hook latches.
10. DO NOT lift people.
11. DO NOT lift or move loads over people.
12. DO NOT operate with side-pulling or side-loading of load to hoist.
13. DO NOT operate a damaged or malfunctioning hoist.
14. DO NOT operate with other than hand power.
15. DO NOT remove, deface, or obscure warning label or labels on hoist.
16. DO NOT leave load suspended when hoist is unattended unless specific precautions have been instituted and are in place.
17. DO NOT lengthen load chain or repair damaged load chain.
18. DO NOT use chain as a ground for welding.
19. WARN personnel of approaching loads.

**FIGURE 1**

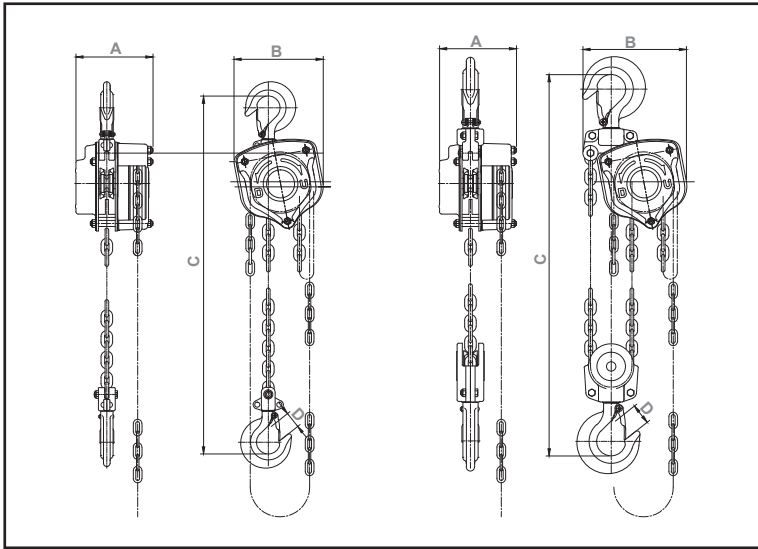

**TABLE 1 - SPECIFICATION**

| MODEL NO :         | DSN0.5     | DSN1       | DSN1.5     | DSN2N      | DSN2       | DSN3       | DSN5       | DSN7.5     | DSN10      | DSN15      | DSN20      | DSN25      | DSN30      | DSN40      |
|--------------------|------------|------------|------------|------------|------------|------------|------------|------------|------------|------------|------------|------------|------------|------------|
| Capacity(SWL) Ton  | 0.5        | 1          | 1.5        | 2          | 2          | 3          | 5          | 7.5        | 10         | 15         | 20         | 25         | 30         | 40         |
| Chainfall No.      | 1          | 1          | 1          | 2          | 1          | 2          | 2          | 3          | 4          | 6          | 8          | 10         | 12         | 16         |
| Standard lift m    | 2.5        | 2.5        | 2.5        | 3          | 3          | 3          | 3          | 3.5        | 3.5        | 3.5        | 3.5        | 3.5        | 3.5        | 3.5        |
| Load chain dia. mm | 6.3 x 19.1 | 6.3 x 19.1 | 7.1 x 21.0 | 6.3 x 19.1 | 7.9 x 23.0 | 7.1 x 21.0 | 9.0 x 27.0 | 9.0 x 27.0 | 9.0 x 27.0 | 9.0 x 27.0 | 9.0 x 27.0 | 9.0 x 27.0 | 9.0 x 27.0 | 9.0 x 27.0 |
| Hand chain mm      | 5.0 x 22.8 | 5.0 x 22.8 | 5.0 x 22.8 | 5.0 x 22.8 | 5.0 x 22.8 | 5.0 x 22.8 | 5.0 x 22.8 | 5.0 x 22.8 | 5.0 x 22.8 | 5.0 x 22.8 | 5.0 x 22.8 | 5.0 x 22.8 | 5.0 x 22.8 | 5.0 x 22.8 |
| Net weight Kg      | 11         | 12         | 14         | 18         | 22         | 23         | 41         | 55         | 95         | 150        | 200        | 393        | 536        | 696        |
| Pulling efforts Kg | 18         | 33         | 34         | 33         | 34         | 35         | 39         | 40         | 41         | 41 x 2     | 41 x 2     | 41 x 2     | 41 x 2     | 41 x 2     |
| A (Dimension) mm   | 147        | 147        | 147        | 150        | 184        | 147        | 185        | 185        | 185        | 212        | 212        | 388        | 426        | 502        |
| B                  | 145        | 145        | 164        | 179        | 187        | 206        | 258        | 367        | 367        | 745        | 873        | 798        | 798        | 798        |
| C                  | 310        | 330        | 360        | 430        | 380        | 480        | 620        | 720        | 820        | 850        | 970        | 1500       | 1870       | 1960       |
| D                  | 26         | 30         | 33         | 38         | 38         | 42         | 45         | 45         | 53         | 79         | 85         | 85         | 95         | 95         |

**INSPECTION AND MAINTENANCE**

Prior to initial use, all new, altered, and repaired hoists shall be inspected in accordance with Table 3. Thereafter, inspections shall be conducted at intervals shown in Table 2; and items to be inspected are indicated in Table 3 by F (Frequent) or P (Periodic).

**TABLE 2 - FREQUENCY OF INSPECTION**

| SERVICE* | FREQUENT INSPECTION | PERIODIC INSPECTION |
|----------|---------------------|---------------------|
| Normal   | Monthly             | Annually            |
| Heavy    | Weekly to Monthly   | Semi-Annually       |
| Severe   | Daily to Weekly     | Quarterly           |

**FIGURE 2**



**Frequent Inspections** - Visual inspection by the operator or other authorized person. This inspection includes listening for unusual sounds while the hoist is operated that may indicate deficiencies.

Exception : Brakes require more than audio-visual inspection. Check daily by operating hoist with and without load, stopping at various positions to test holding power and amount of drift, if any occurs.

TO ADJUST BRAKE (Refer to Figure 2) :

1. Fully tighten nut to position A.
2. Slack off nut from position A to position B and insert adjusting spring.

NOTE : Replace brake disc if thickness is less than 2mm.

**Periodic Inspections** - Audio-visual inspection as for Frequent Inspections, with some disassembly to allow a more detailed inspection if external conditions indicate the need.

**TABLE 3 - INSPECTION CHART**

In chart, F indicates Frequent Inspection, P indicates Periodic Inspection

| LOCATION  | CHECK FOR                                 | F                 | P                    | LOCATION   | CHECK FOR   | F                   | P |
|---|---|-------------------|----------------------|--|---|---------------------|---|
| Braking mechanism<br>(See Page 2)   | Slipping under load                       | ✓                 |                      | Hook Retaining<br>Members (Pins,<br>Bolts, Nuts)                                 | Not tight or secure   |                     | ✓ |
|   | Hard to release                           | ✓                 |                      |  |   |                     |   |
| Brake Parts   | Brake Discs                               | Glazing           |                      | Hook Latch   | Damaged; does not close                                       | ✓                   |   |
|   |   | Oil contamination |                      | Suspension Members   | Excessive wear  |                     | ✓ |
| Pawl; Ratchet   | Excessive wear                            |                   | ✓                    | (Sheaves, hand-<br>wheels, chain<br>attachments,<br>suspension bolts<br>or pins) | Distortion  |                     | ✓ |
| Pawl Spring   | Corrosion; stretch                        |                   | ✓                    |  | Cracks  | ✓                   | ✓ |
| Load Chain<br><br>(See Page 4)  | Stretch                                   |                   | ✓                    |  | Bearing; Shafts   | Excessive wear      |   |
|   | Excessive wear                            | ✓                 | ✓                    | Distortion   |   |                     | ✓ |
|   | Twist                                     |                   | ✓                    | Cracks   |   |                     | ✓ |
|   | Broken, cracked, or<br>damaged links      |                   | ✓                    | Inadequate lubrication   |   |                     | ✓ |
|   | Deposits of foreign<br>material           | ✓                 |                      | Gears  |   | Distortion          |   |
| Inadequate lubrication  | ✓   |                   | Broken or worn teeth |  |   | ✓                   |   |
| Hooks<br><br>(See below)  | Chemical damage                           | ✓                 |                      | Load Block;<br>Suspension Hsg.   | Cracks  |                     | ✓ |
|   | Cracks                                    | ✓                 |                      |  | Distortion  | ✓                   | ✓ |
|   | Deformation                               | ✓                 |                      |  | Cracks  |                     | ✓ |
|   | 15% in excess of normal<br>throat opening |                   | ✓                    | Trolley; Supporting<br>Structure   | Possible inability to<br>continue supporting<br>imposed loads |                     | ✓ |
|   | 10° twist from plane of<br>unbent hook    |                   | ✓                    |  | Bolts, Nuts, Rivets   | Not tight or secure |   |
| Cracks (dye penetrant,<br>magnetic particle, or other<br>suitable detection method) |   | ✓                 |                      | WARNING Label  | Removed or illegible  | ✓                   |   |

# HOOKS

Inspect hooks and measure hook throat opening at least once a month. Between regular inspections check visually daily for deformation, distortion, twisting, damage, and missing or damaged hook latches. Inspect as follows :

1. Measure hook throat opening from metal to metal of the hook as shown by dimension N in Figure 3. DO NOT measure from latch to metal. Hook must be replaced when throat opening measurement has increased 15% over the original throat opening dimension of a new hook, as follows:

**FIGURE 3**

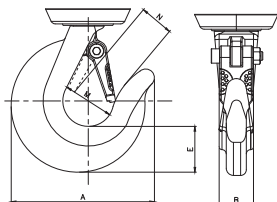

**TABLE 4 - HOOK SPECIFICATION**

| Capacity | Standard Hook Dimension |         |         |         |         | For maintenance<br>(replacement required) |
|----------|-------------------------|---------|---------|---------|---------|---|
|          | A<br>mm                 | B<br>mm | E<br>mm | M<br>mm | N<br>mm | * maximum throat opening<br>= N x 115%    |
| 0.5ton   | 73                      | 16      | 20      | 36      | 31      | 35.7                                      |
| 1ton     | 86                      | 20.5    | 24      | 40      | 33.5    | 38.5                                      |
| 1.5ton   | 99                      | 24      | 28.5    | 45.5    | 38      | 43.7                                      |
| 2ton     | 113                     | 24      | 30      | 50      | 43      | 49.5                                      |
| 3ton     | 133                     | 28      | 42      | 54      | 46      | 52.9                                      |
| 5ton     | 152                     | 38      | 46      | 61      | 51      | 58.7                                      |
| 7.5ton   | 185                     | 42      | 66      | 71      | 50      | 57.5                                      |
| 10ton    | 236                     | 62      | 90      | 83      | 67      | 77  |
| 15ton    | 270                     | 65      | 92      | 108     | 86      | 98.9                                      |
| 20ton    | 323                     | 78      | 120     | 120     | 93      | 107                                       |
| 25ton    | 323                     | 78      | 120     | 120     | 93      | 107                                       |
| 30ton    | 323                     | 78      | 120     | 120     | 93      | 107                                       |
| 40ton    | 384                     | 100     | 135     | 140     | 113     | 130                                       |

2. Measure hook depth at load bearing point (base, bowl, or saddle) of the hook. Hook must be replaced when wear at load bearing point is 10% of the original depth of the hook load bearing point.
3. A bend or twist of the hook exceeding 10° from the plane of the unbent hook requires replacement of the hook.
4. A hook latch, when required, that is missing shall be replaced.
5. A hook latch, when required, that is inoperative shall be repaired or replaced.
6. A hook with a hook latch that does not close the throat opening of the hook shall be removed from service or moused until the latch is replaced or repaired.
7. Hooks having damage from chemicals, corrosion, or deformation shall be repaired or replaced. Damage in the form of cracks, nicks, and gouges may be repaired by a designated person by grinding longitudinally, following the contour of the hook, provided no dimension of the hook is reduced by more than 10% of the original dimension of a new hook. If the repair reduces the dimension of the hook by more than 10% of the original dimension of a new hook, the hook shall be replaced.



## NOTICE

ANY HOOK THAT REQUIRES REPLACEMENT BECAUSE OF EXCESSIVE BENDS, TWISTS, OR THROAT OPENING INDICATES ABUSE OR OVERLOADING OF THE HOIST. THEREFORE, OTHER LOAD-SUPPORTING COMPONENTS OF THE HOIST SHOULD BE INSPECTED FOR POSSIBLE DAMAGE WHEN SUCH CONDITIONS ARE FOUND.

## ⚠ CAUTION

NEVER REPAIR HOOKS BY WELDING OR RESHAPING. HEAT APPLIED TO THE HOOK WILL ALTER THE ORIGINAL HEAT TREATMENT OF THE HOOK MATERIAL AND REDUCE THE STRENGTH OF THE HOOK.

NEVER WELD HANDLES OR OTHER ATTACHMENTS TO THE HOOK. HEAT APPLIED TO THE HOOK WILL ALTER THE ORIGINAL HEAT TREATMENT OF THE HOOK MATERIAL AND REDUCE THE STRENGTH OF THE HOOK.

## CHAIN

Inspect chain at least once a month. Between regular inspections, check visually daily for nicks, gouges, weld splatter, corrosion, or distorted links. Inspect chain thoroughly if it does not feed smoothly over load sheaves. Inspect as follows:

1. Clean chain with solvent before inspection.
2. Test hoist with load and observe operation of chain over load sheaves.
3. Slacken chain and inspect contact points for excessive wear. Refer to Figure 3.
4. Using caliper-type gauge, measure outside length of 11 links under light tension. Refer to Figure 4. Replace chain if measurement exceeds maximum allowable gauge length as follows:

**FIGURE 4**

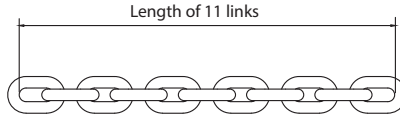

**FIGURE 5**



**TABLE 5**

| CAPACITY<br>TON | CHAIN WIRE<br>DIAMETER | MAXIMUM ALLOWABLE<br>GAUGE LENGTH |
|-----------------|------------------------|-----------------------------------|
|                 | mm                     |                                   |
| 1/2             | 6.3                    | 11 links = 228.8 mm               |
| 1               | 6.3                    | 11 links = 228.8 mm               |
| 1.5             | 7.1                    | 11 links = 251.9 mm               |
| 2               | 7.9                    | 11 links = 276.3 mm               |
| 3               | 7.1                    | 11 links = 251.9 mm               |
| 5               | 9.0                    | 11 links = 323.8 mm               |
| 7.5             | 9.0                    | 11 links = 323.8 mm               |
| 10              | 9.0                    | 11 links = 323.8 mm               |
| 15              | 9.0                    | 11 links = 323.8 mm               |
| 20              | 9.0                    | 11 links = 323.8 mm               |
| 25              | 9.0                    | 11 links = 323.8 mm               |
| 30              | 9.0                    | 11 links = 323.8 mm               |
| 40              | 9.0                    | 11 links = 323.8 mm               |

**FIGURE 6**



**FIGURE 7**



**To install end anchor when replacing load chain:**

1. Slip End Anchor Pin through end link of chain (Refer to Figure 5).
2. Assemble Part A of End Anchor to Part B (Refer to Figure 7).
3. Assemble End Anchor between Sideplates I and II.
  - a. Insert End Pin through holes in End Anchor parts A and B.
  - b. Eliminate any twist in chain.
  - c. Insert end of End Pin into End Spring, and assemble into Sideplate I (Refer to Figure 6).
  - d. Depress spring with pin until opposite end of pin will slide into hole in Sideplate I.
  - e. Check that pin is securely fastened.

**LUBRICATION**

Apply NLGI No. 2 grease to gears as required.  
 Lubricate load chain with AGMA No. 2 oil.

# CHAIN BLOCK EXPLODE VIEW

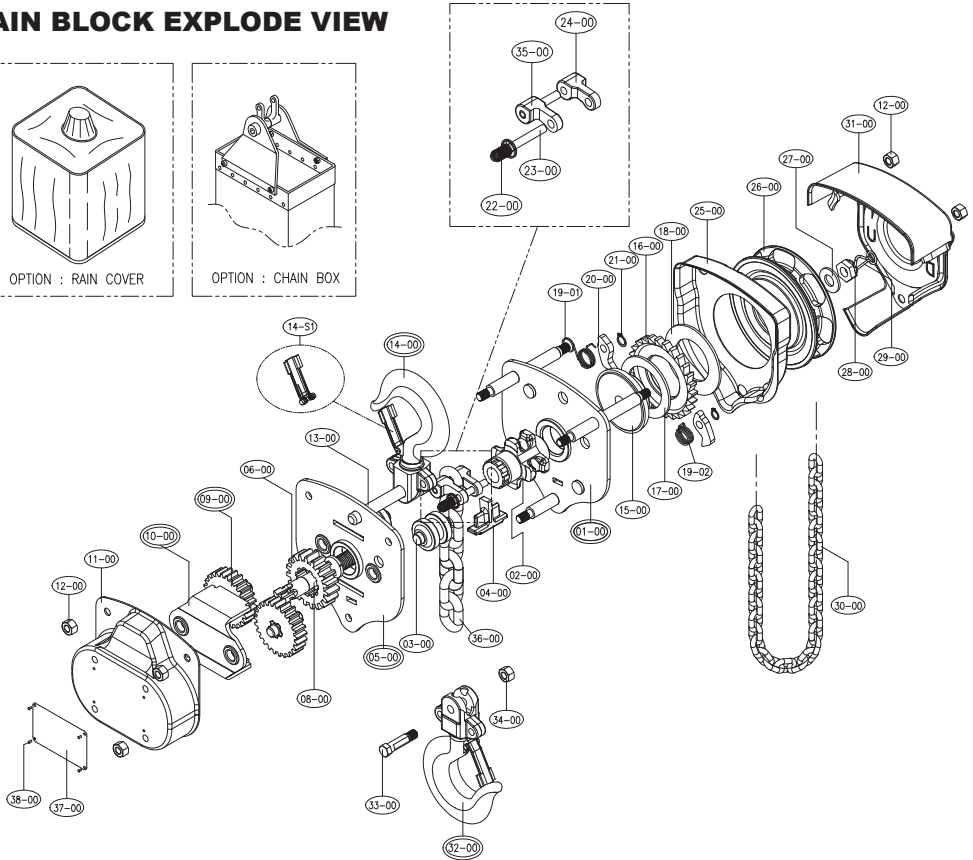
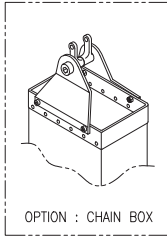
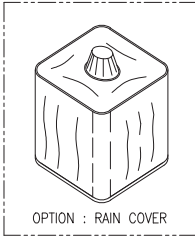

3 TON

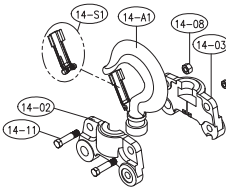

14-00 TOP HOOK ASS'Y

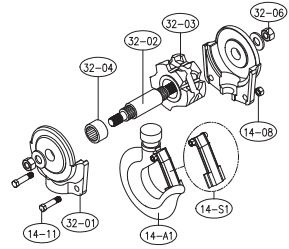

32-00 BOTTOM HOOK ASS'Y

5 TON

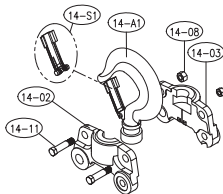

14-00 TOP HOOK ASS'Y

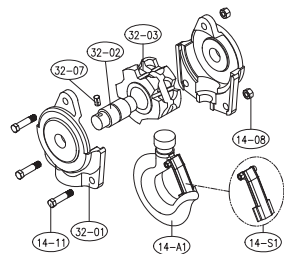
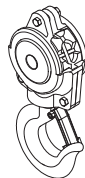

32-00 BOTTOM HOOK ASS'Y

7.5 TON

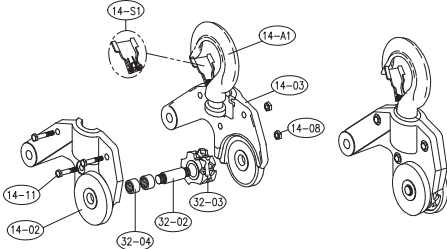

14-00 TOP HOOK ASS'Y

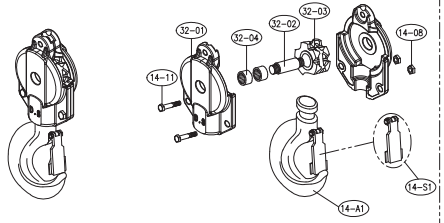

32-00 BOTTOM HOOK ASS'Y

10 TON

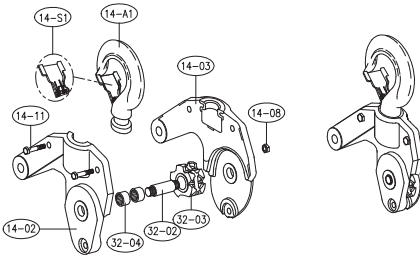

14-00 TOP HOOK ASS'Y

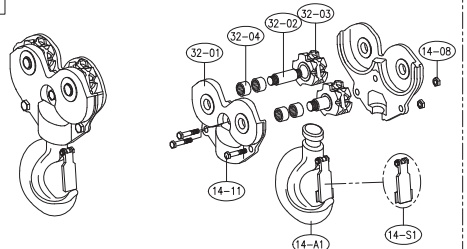

32-00 BOTTOM HOOK ASS'Y

15 TON

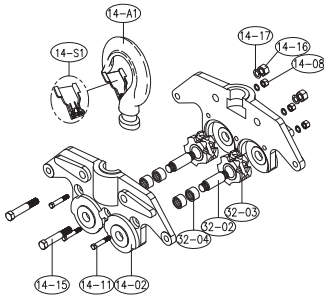

14-00 TOP HOOK ASS'Y

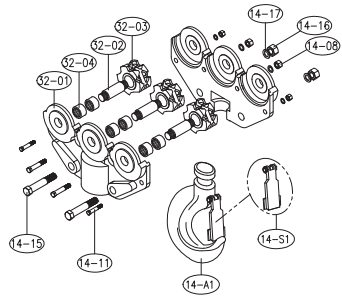

32-00 BOTTOM HOOK ASS'Y

20 TON

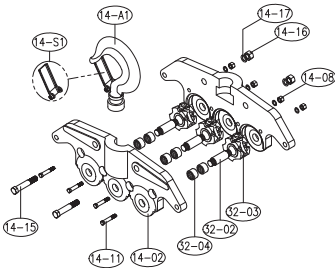

14-00 TOP HOOK ASS'Y

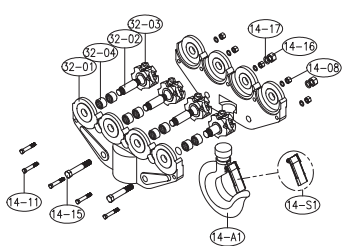

32-00 BOTTOM HOOK ASS'Y

| Item  | Description          | Quantity |     |      |       |       |    |    |      |     |     |     |     | Remark |  |
|-------|----------------------|----------|-----|------|-------|-------|----|----|------|-----|-----|-----|-----|--------|--|
|       |                      | 0.5T     | 1T  | 1.5T | 2T(W) | 2T(S) | 3T | 5T | 7.5T | 10T | 15T | 20T |     |        |  |
| 01-00 | SIDE PLATE 1         |          |     |      |       |       | 1  |    |      |     |     |     |     |        |  |
| 02-00 | LOAD SHEAVE          |          |     |      |       |       | 1  |    |      |     |     |     |     |        |  |
| 03-00 | GUIDE                |          |     |      |       |       | 2  |    |      |     |     |     |     |        |  |
| 04-00 | STRIPPER             |          |     |      |       |       | 1  |    |      |     |     |     |     |        |  |
| 05-00 | SIDE PLATE 2         |          |     |      |       |       | 1  |    |      |     |     |     |     |        |  |
| 06-00 | 1st GEAR             |          |     |      |       |       | 1  |    |      |     |     |     |     |        |  |
| 08-00 | PINION SHAFT         |          |     |      |       |       | 1  |    |      |     |     |     |     |        |  |
| 09-00 | 2nd GEAR&3rd GEAR    |          |     |      |       |       | 2  |    |      |     |     |     |     |        |  |
| 10-00 | SUPPORT PLATE        |          |     |      |       |       | 1  |    |      |     |     |     |     |        |  |
| 11-00 | GEAR COVER           |          |     |      |       |       | 1  |    |      |     |     |     |     |        |  |
| 12-00 | U-NUT                |          |     |      |       |       | 6  |    |      |     |     |     |     |        |  |
| 13-00 | TOP HOOK PIN         |          |     |      |       |       | 1  |    |      |     |     |     |     |        |  |
| 14-00 | TOP HOOK ASSEMBLY    |          |     |      |       |       | 1  |    |      |     |     |     |     |        |  |
| 14-A1 | HOOK                 |          | N/A |      | 2     | N/A   |    |    |      | 2   |     |     |     |        |  |
| 14-S1 | SAFETY LATCH SET     |          |     |      |       |       | 2  |    |      |     |     |     |     |        |  |
| 14-02 | TOP FRAME A          |          | N/A |      | 1     | N/A   |    |    | 1    |     |     |     | 2   |        |  |
| 14-03 | TOP FRAME B          |          | N/A |      | 1     | N/A   |    |    | 1    |     |     |     | N/A |        |  |
| 14-08 | U-NUT(HEX NUT SW)    |          | N/A |      | 4     | N/A   | 4  |    | 5    |     |     |     | 7   | 9      |  |
| 14-11 | HEX BOLT A           |          | N/A |      | 4     | N/A   | 4  |    | 5    |     |     |     | 7   | 9      |  |
| 14-15 | HEX BOLT B           |          |     |      |       | N/A   |    |    |      |     |     |     | 4   |        |  |
| 14-16 | HEX NUT              |          |     |      |       | N/A   |    |    |      |     |     |     | 4   |        |  |
| 14-17 | SPRING WASHER        |          |     |      |       | N/A   |    |    |      |     |     |     | 4   |        |  |
| 15-00 | HUB                  |          |     |      |       |       | 1  |    |      |     |     |     |     |        |  |
| 16-00 | RATCHET GEAR         |          |     |      |       |       | 1  |    |      |     |     |     |     |        |  |
| 17-00 | DISC-A               |          |     |      |       |       | 1  |    |      |     |     |     |     |        |  |
| 18-00 | DISC-B               |          |     |      |       |       | 1  |    |      |     |     |     |     |        |  |
| 19-01 | PAWL SPRING A        |          |     |      |       |       | 1  |    |      |     |     |     |     |        |  |
| 19-02 | PAWL SPRING B        |          |     |      |       |       | 1  |    |      |     |     |     |     |        |  |
| 20-00 | PAWL                 |          |     |      |       |       | 2  |    |      |     |     |     |     |        |  |
| 21-00 | SNAP RING            |          |     |      |       |       | 2  |    |      |     |     |     |     |        |  |
| 22-00 | END SPRING           |          |     |      |       |       | 1  |    |      |     |     |     |     |        |  |
| 23-00 | END PIN              |          |     |      |       |       | 1  |    |      |     |     |     |     |        |  |
| 24-00 | ANCHOR-A             |          |     |      |       |       | 1  |    |      |     |     |     |     |        |  |
| 25-00 | BRAKE COVER          |          |     |      |       |       | 1  |    |      |     |     |     |     |        |  |
| 26-00 | HAND WHEEL           |          |     |      |       |       | 1  |    |      |     |     |     |     |        |  |
| 27-00 | WHEEL WASHER         |          |     |      |       |       | 1  |    |      |     |     |     |     |        |  |
| 28-00 | PINION NUT           |          |     |      |       |       | 1  |    |      |     |     |     |     |        |  |
| 29-00 | R PIN                |          |     |      |       |       | 1  |    |      |     |     |     |     |        |  |
| 30-00 | HAND CHAIN           |          |     |      |       |       | -  |    |      |     |     |     |     |        |  |
| 31-00 | WHEEL COVER          |          |     |      |       |       | 1  |    |      |     |     |     |     |        |  |
| 32-00 | BOTTOM HOOK ASSEMBLY |          |     |      |       |       | 1  |    |      |     |     |     |     |        |  |
| 32-01 | BOTTOM FRAME         |          | N/A |      | 2     | N/A   |    |    | 2    |     |     |     | 1   |        |  |
| 32-02 | AXLE                 |          | N/A |      | 1     | N/A   | 1  |    | 2    |     | 3   |     | 5   | 7      |  |
| 32-03 | SHEAVE               |          | N/A |      | 1     | N/A   | 1  |    | 2    |     | 3   |     | 5   | 7      |  |
| 32-04 | NEEDLE BEARING       |          | N/A |      | 1     | N/A   | 1  |    | 4    |     | 6   |     | 10  | 14     |  |
| 32-06 | U-NUT PW             |          | N/A |      | 2     | N/A   | 2  |    |      |     | N/A |     |     |        |  |
| 32-07 | SPRING PIN           |          |     |      | N/A   |       |    |    | 1    |     |     |     | N/A |        |  |
| 33-00 | HOOK BOLT            |          |     |      |       |       | 1  |    |      |     |     |     | N/A |        |  |
| 34-00 | U-NUT                |          |     |      |       |       | 1  |    |      |     |     |     | N/A |        |  |
| 35-00 | ANCHOR-B             |          |     |      |       |       | 1  |    |      |     |     |     |     |        |  |
| 36-00 | LOAD CHAIN           |          |     |      |       |       | -  |    |      |     |     |     |     |        |  |
| 37-00 | LABEL                |          |     |      |       |       | 1  |    |      |     |     |     |     |        |  |
| 38-00 | RIVET                |          |     |      |       |       | 4  |    |      |     |     |     |     |        |  |
|       | RAIN COVER           |          |     |      |       |       | 1  |    |      |     |     |     |     |        |  |
|       | CHAIN BOX            |          |     |      |       |       | 1  |    |      |     |     |     |     |        |  |

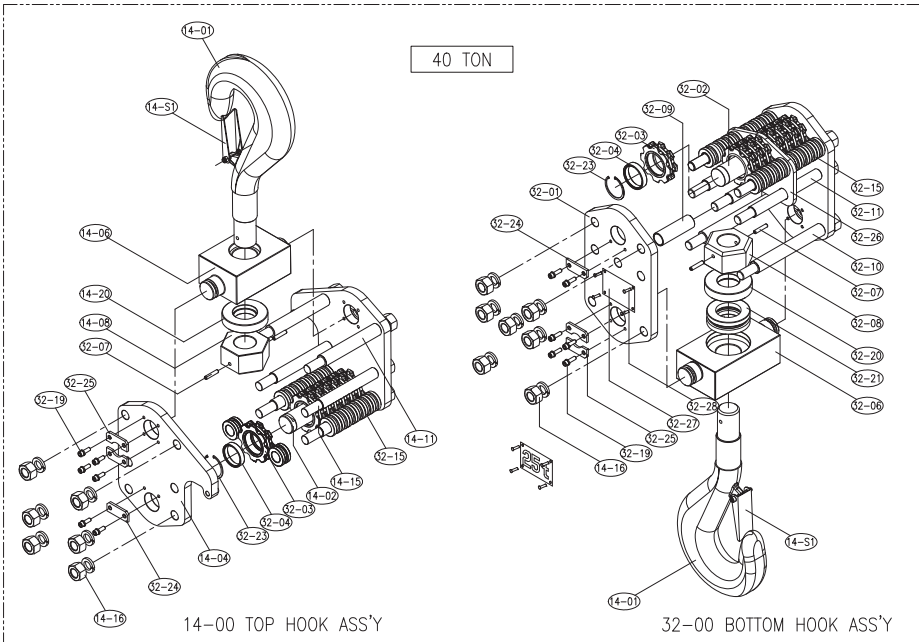
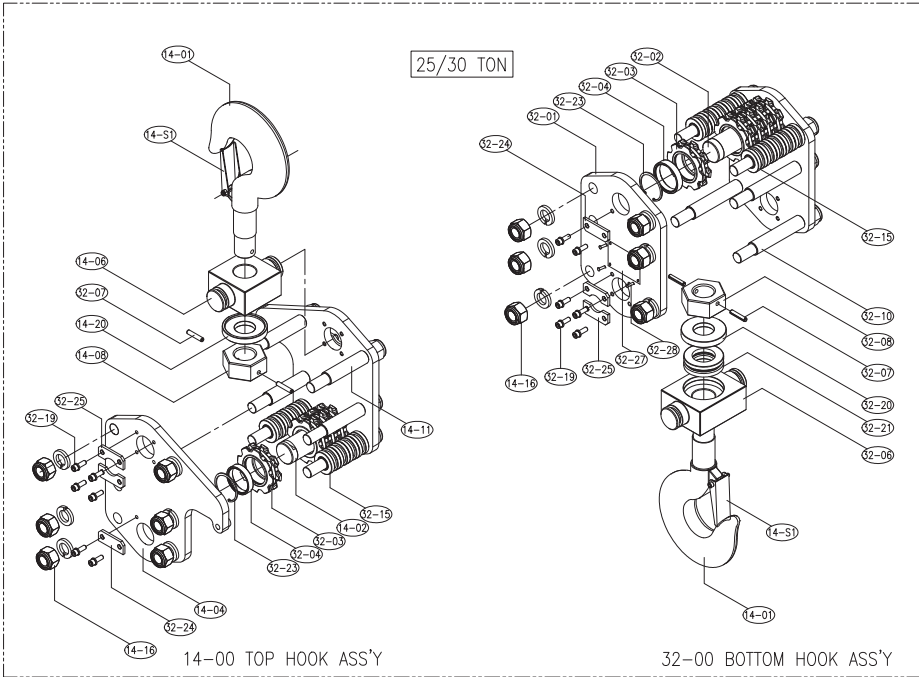

| Item  | Description       | Quantity |     |     | Remark | Item  | Description            | Quantity |     |     | Remark |
|-------|-------------------|----------|-----|-----|--------|-------|------------------------|----------|-----|-----|--------|
|       |                   | 25T      | 30T | 40T |        |       |                        | 25T      | 30T | 40T |        |
| 14-00 | TOP HOOK ASS'Y    | 1        |     |     |        | 14-16 | HEX NUT S/W            | 14       |     |     |        |
| 14-01 | HOOK              | 1        |     |     |        | 32-01 | LOAD BLOCK PLATE       | 2        |     |     |        |
| 14-02 | SHEAVE PIN        | 1        |     |     |        | 32-02 | SHEAVE PIN             | 1        |     |     |        |
| 14-04 | LOAD BLOCK PLATE  | 2        |     |     |        | 32-03 | IDLE SHEAVE            | 5        | 6   | 8   |        |
| 14-06 | TURNING           | 1        |     |     |        | 32-04 | NEEDLE BEARING         | 5        | 6   | 8   |        |
| 14-08 | HOOK NUT          | 1        |     |     |        | 32-06 | TURNING(BOTTOM)        | 1        |     |     |        |
| 14-11 | STAY BOLT A       | 6        | 6   | 2   |        | 32-07 | SPRING PIN             | 2        |     |     |        |
| 14-S1 | SAFETY LATCH SET  | 2        |     |     |        | 32-08 | HOOK NUT               | 1        |     |     |        |
| 14-15 | STAY BOLT B       | N/A      | N/A | 4   |        | 32-09 | STAY PIPE              | N/A      | N/A | 2   |        |
| 14-16 | HEX NUT S/W       | 12       |     |     |        | 32-10 | STAY BOLT A            | 6        | 6   | 2   |        |
| 14-20 | BEARING CAP       | 1        |     |     |        | 32-11 | STAY BOLT B            | N/A      | N/A | 5   |        |
| 32-03 | IDLE SHEAVE       | 4        | 5   | 7   |        | 32-15 | GUIDE ROLLER           | 10       | 12  | 16  |        |
| 32-04 | NEEDLE BEARING    | 4        | 5   | 7   |        | 32-19 | HEX WRENCH BOLT        | 12       |     |     |        |
| 32-07 | SPRING PIN        | 2        |     |     |        | 32-20 | BEARING CAP            | 1        |     |     |        |
| 32-15 | GUIDE ROLLER      | 8        | 10  | 14  |        | 32-21 | THRUST BEARING         | 1        |     |     |        |
| 32-19 | HEX WRENCH BOLT   | 12       |     |     |        | 32-23 | SNAP RING              | 5        | 6   | 8   |        |
| 32-23 | SNAP RING         | 4        | 5   | 7   |        | 32-24 | KEY PLATE A            | 2        |     |     |        |
| 32-24 | KEY PLATE A       | 2        |     |     |        | 32-25 | KEY PLATE B            | 4        |     |     |        |
| 32-25 | KEY PLATE B       | 4        |     |     |        | 32-26 | SUB BLOCK PLATE        | N/A      | N/A | 1   |        |
| 32-00 | BOTTOM HOOK ASS'Y | 1        |     |     |        | 32-27 | BOTTOM HOOK NAME PLATE | 1        |     |     |        |
| 14-01 | HOOK              | 1        |     |     |        | 32-28 | RIVET                  | 4        |     |     |        |

## NOTICE

TO ORDER PARTS: Provide product name and serial number, hand chain hoist capacity, part number, part description, and quantity required. Use only DAESAN authorized replacement parts in the service and maintenance of this hand chain hoist.

## **GENERAL CONDITIONS OF WARRANTY**

**WARRANTIES:** The Seller warrants to the original using Buyer thereof that the goods sold under this Agreement are free from defects in workmanship and materials for a period of one year from the date of shipment to the original using Buyer. No other express warranties are given and no affirmation of Seller or Seller's agents, by word or action, shall constitute a warranty. No warranty is made for components and accessories made by others when such items are warranted by their respective manufacturers.

Installation or operation of the equipment in any manner other than as recommended by Seller, shall void the warranty.

Any variations in details between the goods furnished herein and those covered in Buyer's specifications are due to standards of manufacture not to be construed as exceptions to the specifications.

### **DISCLAIMER OF IMPLIED WARRANTIES:**

- (a) SELLER MAKES NO WARRANTY OF MERCHANTABILITY IN RESPECT TO THE GOODS SOLD UNDER THIS AGREEMENT.
- (b) This sale is made WITHOUT ANY WARRANTY BY SELLER THAT THE GOODS ARE SUITABLE FOR ANY PARTICULAR PURPOSE..
- (c) Buyer hereby waives all other warranties, guarantees, obligations, liabilities, rights, and remedies arising by law or otherwise including any obligation or liability of the Seller arising from tort, and Buyer shall indemnify Seller from any liability, loss, damage, or claim arising from Buyer's tortious use of the goods sold hereby.

### **REMEDIES:**

- (a) Under no conditions shall any goods be returned to Seller without it's prior written consent.
- (b) The Buyer's sole and exclusive remedy for breach of any warranty is limited to Seller furnishing, at it's expense, duplicate or repaired parts F.O.B. Seller's plant with installation at Buyer's expense if discovery of a claimed defect occurs during the allowable warranty period, and if Seller's inspection determines a defect exists.
- (c) The quantity of material shown by invoice shall in all cases govern settlement for shortages, unless notice of shortage, appropriately documented, is given to the carrier and the Seller upon delivery by the Carrier.
- (d) Claims for errors, deficiencies or imperfections shall be deemed waived by the Buyer unless Seller is notified in writing of the basis of such claims within 10 days after discovery of claimed defect and such discovery occurs within the warranted period.
- (e) Neither Buyer nor User shall be entitled under this Agreement to recover from Seller any incidental or consequential damages of any nature including but not limited to the cost of any labor expended by others in connection with the goods sold hereby by reason of any alleged nonconformity or breach of warranty on the part of the Seller, nor costs of material or account thereof, nor any lost profits whether determinable or speculative.







**DAESAN INOTEC INC.**  
**[www.daesaninotec.com](http://www.daesaninotec.com)**

32-32 Jungahn-Nonggongdangigil, Jungahn-myun, Gongu-si  
Chungeongnam-do, South Korea  
Email: [ygnam@daesanhoist.com](mailto:ygnam@daesanhoist.com) / [swkang@daesanhoist.com](mailto:swkang@daesanhoist.com)  
[www.daesaninotec.com](http://www.daesaninotec.com)